

GP300

Portable Radios

Operating Instructions

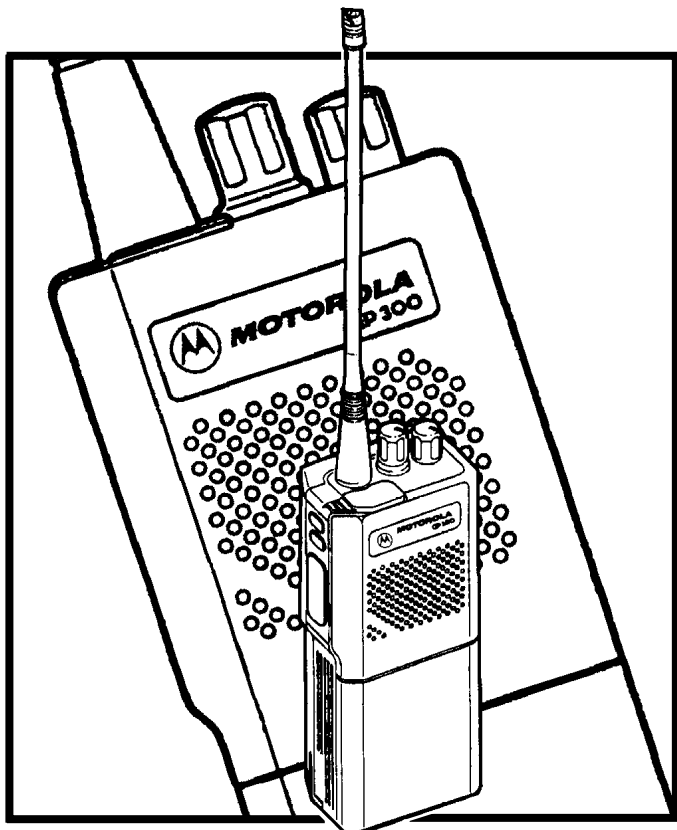



MOTOROLA

2-YEAR LIMITED WARRANTY FOR RADIOS

We thank you for purchasing our Motorola radios. These radios are manufactured according to the highest quality standards set and are backed by Motorola's two (2) year warranty. The rechargeable Motorola supplied batteries have a one (1) year warranty. Kindly approach your dealer for more information.

Motorola warrants its radios and batteries against defects in material and workmanship under normal use and service for the period stated above.

Motorola recommends that you use Motorola supplied accessories and batteries in connection with the radio. We would also advise you against attempting any modifications or repairs or any other form of unauthorised service to your radio.

Should you have any queries, please contact:

Singapore -Telephone/Fax: (65)2812053/2874181

Beijing -Telephone/Fax: (86-10)68438231/4610277

Please see the next page for more information.

Fill in the details of your radio below for your own reference:

Model Name/No.:

Serial Number:

Date of Purchase:

Dealer Name:

Address:

Telephone:

LIMITED WARRANTY

MOTOROLA RADIO PRODUCTS

This express limited warranty covers the Product manufactured by MOTOROLA Radio Products Group and applies to any warranty already mentioned. MOTOROLA assumes no obligations or liability for additions or modifications to this warranty unless **specifically** made in writing and signed by an authorised officer of MOTOROLA.

MOTOROLA cannot be responsible in any way for any ancillary equipment not furnished by MOTOROLA which is attached to or used in connection with the Product, or for operation of the Product with any ancillary equipment, and all such equipment is expressly excluded from this warranty. Because each system which may use the Product is unique, MOTOROLA disclaims liability for range, coverage, or operation of the system as a whole under this warranty.

This warranty sets forth the full extent of MOTOROLA'S responsibilities regarding the Product. Repair, replacement or refund of the purchase price, at MOTOROLA'S option, is the sole and exclusive remedy of purchaser/user of the Product. THIS WARRANTY IS GIVEN IN LIEU OF ALL OTHER EXPRESS WARRANTIES. IMPLIED WARRANTIES, INCLUDING WITHOUT LIMITATION, IMPLIED WARRANTIES OF MERCHANTABILITY AND FITNESS FOR A PARTICULAR PURPOSE, ARE **HEREBY EXCLUDED**. IN NO EVENT SHALL MOTOROLA BE LIABLE FOR DAMAGES IN EXCESS OF THE PURCHASE PRICE OF THE PRODUCT, FOR ANY LOSS OF USE, LOSS OF TIME, INCONVENIENCE, COMMERCIAL LOSS, LOST PROFITS OR SAVINGS OR OTHER INCIDENTAL, SPECIAL OR CONSEQUENTIAL DAMAGES ARISING OUT OF THE USE OR INABILITY TO USE SUCH PRODUCT, TO THE FULL EXTENT SUCH MAY BE DISCLAIMED BY LAW.

Notwithstanding anything contained herein, MOTOROLA shall not be liable for any of the following situations:

- A) Defects or damage resulting from use of the Product in other than its normal and customary manner.
- B) Defects or damage from misuse, accident, water, liquid or neglect.
- C) Defects or damage from improper or unauthorized testing, operation, maintenance, service, repair, installation, alteration, modification, or adjustment.
- D) Product which has had the serial number removed or made illegible.
- E) A Product which, due to illegal or unauthorized alteration of the software/firmware in the Product, does not function in accordance with Motorola's published specifications or the FCC type acceptance labeling in effect for the Product at the time the Product was initially distributed from Motorola.
- F) Scratches or other cosmetic damage to Product surfaces that does not affect the operation of the Product.

MOTOROLA shall have no liability whatsoever with respect to any claim of patent infringement which is based upon the combination of the Product or parts furnished hereunder with software, apparatus or devices not furnished by MOTOROLA, nor will MOTOROLA have any liability **whatsoever** for the use of ancillary equipment or software not furnished by MOTOROLA which is attached to or used in connection with the Product.

HOW TO GET WARRANTY SERVICE: Provide proof of purchase and deliver or send the Product item, transportation and insurance prepaid, to an authorized warranty service location. Warranty service will be provided by Motorola through one of its authorized warranty service locations. If you contact the company that sold you the Product, it can facilitate your obtaining warranty service. You can also call Motorola for assistance: 65-2812053 (Singapore) or 86-10-68438231 (Beijing).

Motorola Penang
Bayan Lepas Free Industrial Zone
Phase III
11900 Penang, Malaysia

6804370J52-B

WARNING

Certain combinations of chemical environments can adversely affect thermoplastic resins, the material the housing of the radio is made from. For this reason, lubricants, cleaning agents, solvents or any other material which may come in contact with the housing of the radio should be carefully evaluated for compatibility. We recommend a mild dishwashing soap for cleaning the exterior of the product.

Recycling or Disposal of Batteries

This portable radio is powered by a nickel-cadmium (Ni-Cad) rechargeable battery. At the end of its useful life, the battery can be recycled. However, recycling facilities may not be available in all areas. Under various state or local laws, the battery must be recycled or disposed of properly and cannot be disposed of in landfills or incinerators.

In addition, U.S. Environmental Protection Agency (EPA) regulations classify used Ni-Cad batteries as hazardous waste, unless certain exemptions apply.

Motorola fully endorses and encourages the recycling of Ni-Cad batteries. If you are located in the United States, you can ship post paid your used Ni-Cad batteries to INMETCO, an EPA approved recycling facility, at this address:

INMETCO
P.O. Box 720
245 Portersville Road
Ellwood City, PA 16117
Telephone: (412) 758-5515
Fax: (412) 758-9311

Consideration should be given to the methods of collecting, labeling, and shipping used Ni-Cad batteries. Your federal, state or local EPA should be consulted for specific legal requirements and for recycling options in your area.

Motorola, as a responsible corporate citizen, has always been concerned with the protection of the environment. Please feel free to call the phone number 1-800-422-4210 for further information.

Quick Reference Card

Antenna Installation

Rotate the antenna clockwise until hand tight into the antenna connector on the top of the radio.

Battery Installation or Replacement

1. Turn off the radio and hold it with the back of the radio facing up.
2. Disengage the battery latch on the bottom of the radio by pushing and holding the latch towards the front of the radio. (See Figure 1.)

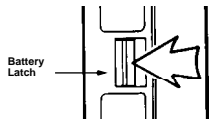

Figure 1.

3. While holding the battery latch, slide the battery down from the top of the radio about 1/2 of an inch. Once the battery is free from the control rails, lift it directly upward to remove.
4. To install a fresh battery, align the belt clip end of the battery with the control rails on the radio. (See Figure 2.) Slide the battery

toward the top of the radio until it is fully engaged by the battery latch.

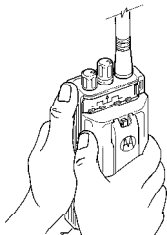

Figure 2.

To Receive

1. Turn the radio on and rotate the CHANNEL SELECTOR to the desired channel position. (See Figure 3.)
2. Listen for a transmission or hold the MONITOR BUTTON to hear back-ground noise. Adjust the VOLUME CONTROL to a comfortable listening level. (See Figure 4.)
3. To monitor a channel (disable PL/DPL) press the side mounted CONTROL BUTTON. The LED glows yellow for 4 seconds to confirm that the coded squelch is disabled. To reverse the monitor status, press this button again.

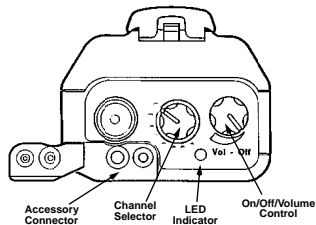

Figure 3.

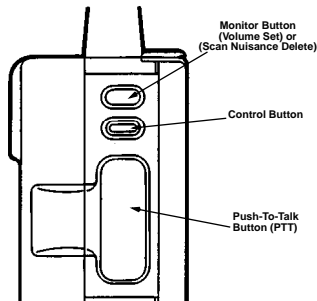

Figure 4.

To Transmit

1. Turn the radio on and rotate the CHANNEL SELECTOR to the desired channel position.
2. Press the MONITOR BUTTON to listen for activity on your channel.
3. While holding the radio two to three inches from your mouth, press the PTT button on the side of the radio and speak. The LED glows red to indicate transmit status. When finished transmitting, release the PTT button to receive.

NOTE

When the PTT button is depressed, the LED flashes red if there is a low battery condition. In addition, a double alert tone is sounded when the PTT button is released.

Time-Out-Timer (T.O.T)

The T.O.T feature ends a transmission which is over 60 seconds in length. After time out, a continuous alert tone sounds until the PTT button is released.

Voice Activated Transmission (VOX)

To activate the VOX feature, insert a headset in the accessory connector on a channel programmed for VOX. You can gain manual control of the radio by pressing the PTT button at any time. In order to restart the VOX feature, the radio must be turned off/on or the channel must be changed.

Optional Feature Enhancements (Not Available on 2 Channel Models)

Channel Scan

To initiate the scan feature, rotate the CHANNEL SELECTOR to the location with the scan list programmed to it. The radio will stop on any active channel and you will be able to hear the conversation. The radio scans for PL/DPL unless the monitor feature is active and CSQ scan will operate. To locate the last active scan channel, rotate the CHANNEL SELECTOR and the radio beeps when that channel is reached. To temporarily eliminate a channel from the scan list, press the side NUISANCE DELETE BUTTON while the nuisance channel is active.

PTT ID (Encode)

Every time the PTT button is pressed, the radio automatically transmits a unit identification (ID) number. While holding the PTT button, a tone may be heard while the unit ID number is being sent out.

Call Alert (Decode)

When a Call Alert is received, the monitor LED flashes yellow and a series of 4 alert tones sound. A Call Alert "leaves a message" for the mobile operator. The monitor LED continues to flash yellow, and the alert tones repeat every 10 seconds until the PTT or any other button is pressed. The radio then returns to normal operation.

Voice Selective Call (Decode)

When a Voice Selective Call is received, a one-time 2 beep alert tone sounds, the monitor LED flashes yellow and the radio emits a voice message. After the transmission is completed, the radio returns to normal operation.

Contents

Quick Reference Card	front cover flap
Warning.....	inside front cover
Introduction	2
Inspection.....	3
Controls, Switches, Indicators, and Connectors	4
Alert Tone Indicators.....	6
Scan and Signalling Alert Tones.....	8
Multifunctional LED Indicators	9
Dealer Programmable Functions	10

HOW TO OPERATE YOUR GP300 RADIO

Getting Started.....	11
Operation	13
Operation with Standard Features	15
Optional Feature Enhancements	18
Optional Signalling Enhancements.....	21
DTMF Telephone Interconnect	23

BATTERIES, CHARGERS AND ACCESSORIES

Battery Information.....	25
Battery Chargers Operating Instructions.....	27
Accessories.....	30
Belt Clip Installation Instructions	32

SAFETY AND SERVICE

For Use in Hazardous Atmospheres.....	33
Troubleshooting	34
Service	35
General Radio Care	36
Safety Information.....	37
Computer Software Copyrights.....	38
Licensing Information.....	39

 Motorola, GP300, Private-Line, Digital Private-Line, Touch-Code, RapidCall, and Quik-Call II are trademarks of Motorola Inc.

©1997 by Motorola Inc.

Motorola Malaysia Sdn. Bhd. (Company No. 12631DE),

Bayan Lepas Free Industrial Zone, Phase III

11900 Penang, Malaysia

Printed in Malaysia. All Rights Reserved.

Introduction

Welcome To The Motorola GP300 Radio

The Motorola GP300 Portable Radio is a sophisticated state-of-the-art unit. It incorporates the latest technology available in two-way radio communications.

The use of microcomputer technology makes changing radio characteristics such as operating frequencies and squelch codes both economical and fast. Any computer equipped dealer can easily reprogram your radio's operating characteristics, or your radio can be "cloned" from a radio already programmed to your desired frequencies and codes.

The GP300 radio meets tough environmental demands while providing cost effective and reliable communications. It meets the U.S. Government Military Standards 810C, D and E for low pressure, high temperature, low temperature, temperature shock, solar radiation, rain, humidity, salt fog, dust, vibration, and shock. The GP300 radio also meets the Electronic Industry Association RS316B electrical and mechanical specifications. The Motorola Accelerated Life Test (ALT) assures that possible failures brought on by field stress and abuse are identified and designed out of your radio before it reaches your hands.

All of these features provide for better, yet more cost effective communications for you.

Inspection

When you receive your packaged GP300 Radio, inspect the shipping carton for any signs of damage. Next, remove and check the contents of the packing case to be sure that all items ordered have been included. Contents of the packing case may be different from the standard items listed below if optional accessories were ordered.

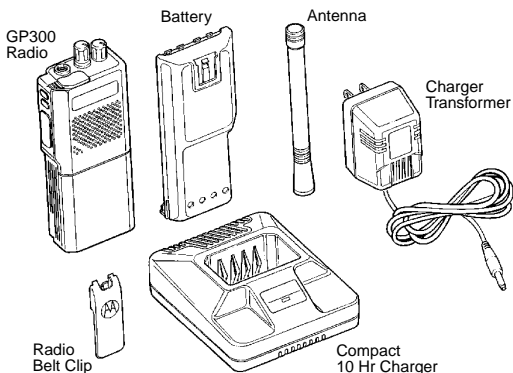

Packaged Model Contents

- GP300 Radio
- Heliflex Antenna (VHF Models) or Flexible Whip Antenna (UHF Models)
- Rapid Charge High Capacity Nickel-Cadmium Battery
- Radio Belt Clip
- Operating Instructions Manual
- Compact 10 Hour Charger and Transformer

Inspect the equipment thoroughly. If any part of the equipment has been damaged in transit, report the extent of the damage to the transportation company immediately.

Controls, Switches, Indicators and Connectors

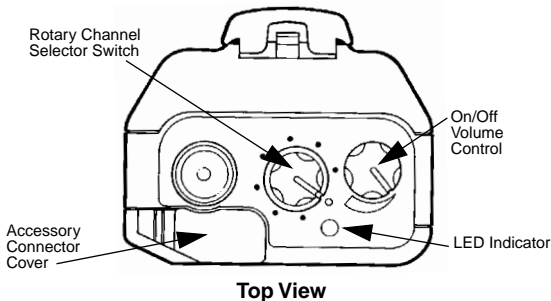

On/Off/Volume Control

Turns the radio on and off and adjusts the volume level.



Vol - Off

Rotary Channel Selector Switch

Selects the operating channel or initiates scan operation (on applicable models).



LED Indicator

A tri-colored light-emitting diode (LED) indicates the radio operating status.



Accessory Connector

Provides accessibility for connection to remote accessories such as a remote speaker microphone.



NOTE

The Accessory Connector Cover protects the Accessory Connector. This cover should remain in place whenever the radio is not being used with an accessory.

Push-To-Talk (PTT) Button

When depressed and held, engages the transmitter and puts radio in the transmit mode. When released, the radio operates in the receive mode.

Monitor Button (PL/DPL Disable)

Selects the mode of operation, carrier squelch (CSQ) or Private-Line/Digital Private-Line (PL/DPL squelch).

Control Button

When depressed, this monitors the channel for any activity. Neither CSQ nor PL/DPL squelch is active when monitoring. The radio has the ability to monitor all activity on the radio channel, whenever this button is pressed. This control button can also be programmed for nuisance channel delete on radio models with the channel scan feature.

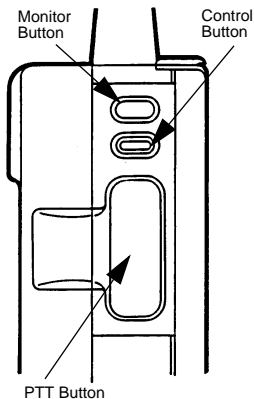

Antenna

Heliflex (VHF models) or a Flexible Whip (UHF models) with threaded base.



Heliflex

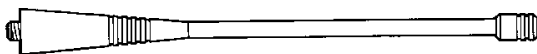

Flexible Whip

Alert Tone Indicators

Power-Up

Each time the radio is turned on, a microcomputer and synthesizer self-test occurs. A high pitched alert tone is generated for approximately 1/8 second to indicate that the microcomputer and synthesizer are functioning properly. A second low pitched tone will then be generated if the start-up test is not successful.

Transmit on Blank or Receive-Only Channels

Pressing the PTT button while tuned to a blank or "receive-only" channel will cause an alert tone. The tone will continue as long as the PTT button is depressed. The radio transmitter is not enabled.

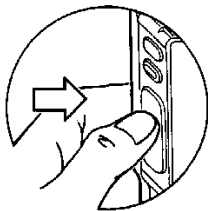

Transmit Inhibit on Busy Channel with Busy Channel Lockout

Pressing the PTT button during a "busy channel" condition (other than your PL/DPL group) generates a continuous busy tone that lasts as long as the button is depressed.

Time-Out-Timer

The Time-Out-Timer (T.O.T.) limits the amount of transmission time to a preset length. At the end of this time an alert tone indicates that your transmission has been cut off. The alert continues as long as the PTT button is depressed.

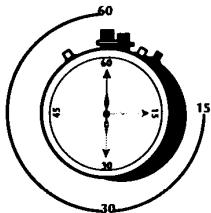

Low Battery Alert

If the battery is low on your radio, an audible alert tone alerts you during transmit or receive mode. During transmit, on the release of the PTT button the radio emits 2 medium pitched chirp tones. During receive/standby mode, the radio emits 2 medium pitched chirp tones. These tones emit approximately every 20 minutes during transmit or receive mode until the battery is completely drained of power.

Scan and Signalling Alert Tones

Transmit on Radios with PTT-ID

When the PTT button is depressed a side tone is heard as the unit I.D. is being transmitted. When the tone ends, start your voice message in the standard manner.

Selective Call

A 2 beep alert tone is generated whenever a Selective Call is received, the radio unsquelches and the callers message is heard.

Call Alert

A 4 beep alert tone is generated whenever a Call Alert (page) is received. The alert tone repeats until the PTT or monitor button is pressed.

Scan Activate

A 1 beep alert tone is heard whenever scan is initiated by selecting a preprogrammed rotary scan channel location.

Priority Alert Tone

A 1 beep alert tone is heard if the radio is scanning and a conversation is initiated on the priority scan channel.

Scan Talkback Tone

A medium pitched 1 beep alert tone is sounded when you rotate the channel selector knob out of the scan position after the radio has locked on a channel and reaches the last active channel within the channel scan list.

Multifunction LED Indicators

Transmit Mode (PTT Button Depressed)

- Continuous Red Light - Normal Transmission
- Flashing Red Light - Low Battery

Receive Mode (PTT Button Not Depressed)

- Flashing Red Light - Channel Busy, indicates the presence of activity on the operating channel
- Continuous Yellow Light (5 seconds) - Channel Monitor Active (PL/DPL Disable)
- Flashing Yellow Light - Selective Call or Call Alert Present
- Flashing Green Light - Channel Scan Feature Active

Dealer Programmable Functions

Per Radio Functions	Default
All Alert Tones	Enabled
All LED Indicators	Enabled
Low Battery Alert	Enabled
Time-Out-Timer	Enabled to 60 seconds
Channel Busy Light	Disabled
Battery Saver	Disabled
VOX Operation	Disabled
Control Button 1	Volume Set
Control Button 2	Monitor (PL Disable)

Per Channel Functions	Default
Rx Frequency	Test
Tx Frequency	Test
PL/DPL Decode	Test
PL/DPL Encode	Test
Rx Only Channel	Disabled
Busy Channel Lockout	Disabled

Channel Scan Functions (Not Available on 2 Channel Models)

Channel Scan List	Test
TalkBack Channel Scan	Enabled
Scan Activate Tone	Enabled
Priority Alert Tone	Disabled
Talk Back Channel Tone	Enabled

Signalling Functions (Not Available on 2 Channel Models)

DTMF Signalling	Disabled
Quik Call Signalling	Disabled
MDC-1200 Signalling	Test

Getting Started

Antenna Installation

Fasten the antenna to the radio by placing the threaded end of the antenna into the large threaded antenna bushing on top of the radio. Rotate the antenna clockwise until hand tight.

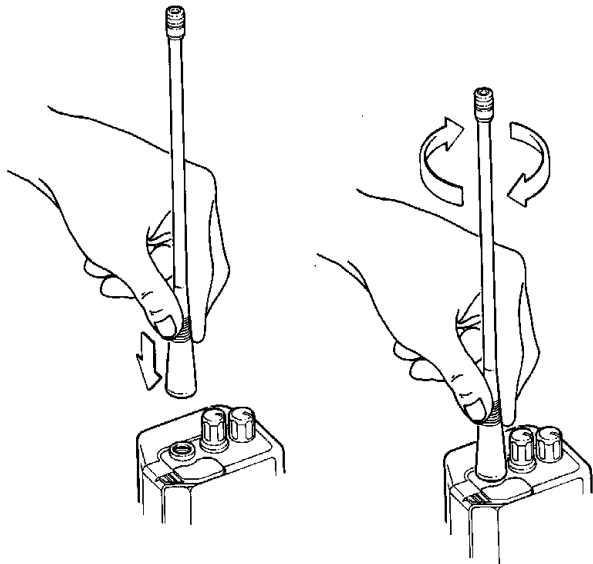

Battery Installation or Replacement

1. Turn off the radio and hold it in one hand with the back of the radio facing up.
2. Disengage the battery latch on the bottom of the radio by pushing and holding the latch towards the front of the radio.
3. With the battery latch disengaged, slide the battery down from the top of the radio about 1/2 of an inch. Once the battery is free from the control rails, lift it directly upward to remove the battery from the radio housing.
4. To install the new or freshly charged battery, align the top of the battery (belt clip end) with the stamped housing figure showing the correct battery positioning. Slide the battery toward the top of the radio until it is fully engaged by the battery latch.

NOTE

Nickel-Cadmium batteries should be fully charged before their first use.

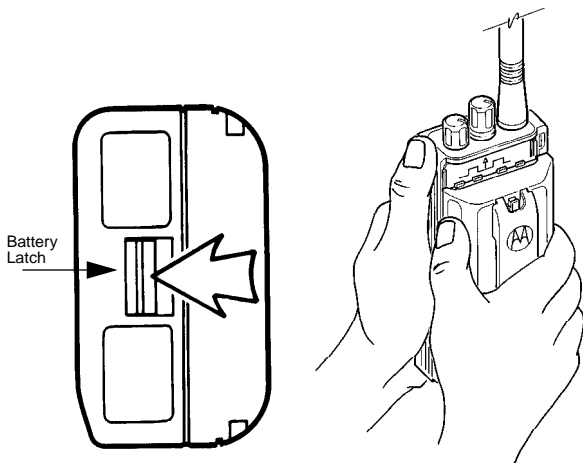

Operation

To Power-Up

Rotate the volume control 1/2 turn clockwise to turn on the radio. A power-up alert tone is generated for approximately 1/8 second to indicate that the radio has passed a self-test of the microcomputer.



NOTE

If the short power-up alert tone is not generated, or if a second low alert tone is generated (indicating corrupted radio programming), turn the radio off, check the battery (charge or replace if necessary), and turn the radio back on again. If the power-up alert tone is still not generated, a fault exists in the radio. Contact your local Motorola dealer.

To Receive

1. Set the channel selector to the desired channel position.
2. Listen for a transmission and adjust the volume control to a comfortable listening level. If no transmission is heard, depress and hold the volume set button to unscquelch the radio (on applicable models), and adjust the background noise to a comfortable listening level.
3. The radio is now set to receive all calls on the selected frequency.
4. If you wish to monitor a channel (disable PL/DPL) press the side mounted monitor button. The LED glows yellow for 4 seconds, to confirm that the coded squelch is disabled. Any time the PTT button is pressed when the GP300 is in the PL/DPL disable mode, the LED temporarily glows yellow to remind you that this state is active. The radio remains in the monitor state until the monitor button is pressed again, to reverse the state.



NOTE

All GP300 radio models have an internal squelch setting which is adjusted at the factory. The squelch level setting is not a user-operated control; however, it may be reprogrammed through the Radio Service Software available at your local Motorola dealer.

To Transmit

1. Set the channel selector to the desired channel position.
2. Do not interrupt another user. Listen for activity on your channel. If the channel on which you are transmitting is programmed to receive PL/DPL, momentarily depress the monitor button to listen for channel activity. The channel must be clear before transmitting.
3. While holding the radio in a vertical position with the speaker-microphone grille two to three inches from your mouth, press the PTT button on the side of the radio and speak slowly and clearly into the grille area. When finished transmitting, release the PTT button to receive. When the PTT button is depressed the LED glows red and remains on for the entire length of the transmission, and turns off when the PTT button is released.

NOTE

When the PTT button is depressed (and as long as the PTT button remains depressed), the battery voltage is automatically monitored and if the voltage is low, the LED flashes red to alert you of the low battery condition. In addition, a double alert tone is sounded when the PTT is released.

NOTE

The power to the radio should be turned OFF when an audio accessory with a microphone is to be connected to the radio. Such items include Headsets w/mics, Speaker-Microphones and Surveillance Microphones. Following this procedure ensures proper operation of the PTT button and other controls.

Operation with Standard Features

To fit your particular needs, a number of features are available to enhance the operation of your GP300 radio. These capability features are described for you in this section.

Time-Out-Timer

The Time-Out-Timer (T.O.T.) feature alerts you if the transmitter is keyed for a long period. This feature prevents channel tie-up and excess battery drain in case of an inadvertent keying of the transmitter. The radio operates normally in the receive mode with the T.O.T. feature. However, in the transmit mode, a single transmission (uninterrupted depression of the PTT) "times-out" after 60 seconds and the radio reverts back to the receive mode, even with the PTT button remaining depressed. After the 60 second time out, a continuous alert tone is generated in the receive mode until the PTT button is released.

Volume Set

Pressing one of the side buttons will initiate the volume set feature, if it has been programmed to perform this function. The radio has the ability to monitor the current radio volume level whenever this button is pressed.

"White noise" will be present for the duration of the button press that indicates the current level setting of the volume control.

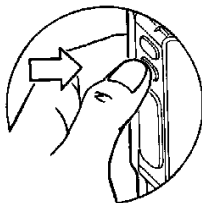

Busy Channel Lockout

Busy Channel Lockout is a privacy feature that prevents the radio from listening to or transmitting over conversations outside its talkgroup, keeping lines of communication clear. Whenever the radio is not allowed to talk, you will hear a busy tone if you attempt to transmit. The radio is allowed to transmit:

1. when the channel is clear
2. during the group's repeater hang time, until a carrier drop is seen
3. when receiving transmissions from your own group (Common PL/DPL code).

Whenever a channel is programmed for PL/DPL busy channel lockout, pressing the monitor button does not put the radio into the carrier squelch mode. This means that radios with PL/DPL busy channel lockout programmed cannot monitor or listen to another group's transmissions. Furthermore, the volume set function is also disabled on any channel that is preprogrammed as a PL/DPL busy channel lockout channel.

On carrier squelch channels, Transmit Inhibit is available to prohibit transmissions when any carrier is present.

Voice Activated Transmission (VOX)

When hands-free operation is desired, the GP300 can be activated by voice alone using the VOX feature. The radio has circuitry and software internal to the radio that senses when you speak through an accessory headset and will automatically transmit. You will know you are transmitting when you hear yourself in the headset speaker. Operation is totally automatic; no external controls are required.

To Activate the VOX Feature

1. Turn the radio off.
2. Insert a headset, without a PTT button, in the accessory connector on a channel programmed for VOX operation.
3. Turn the radio on. The VOX feature will be ready to function. You can operate the radio manually, at any time, by pressing the PTT button.
4. Restart the VOX feature by turning the radio off/on or changing the channel.

NOTE

An external headset accessory must be attached to the GP300 to activate VOX operation. The radio operates normally, using the PTT button, whenever the headset is not attached.

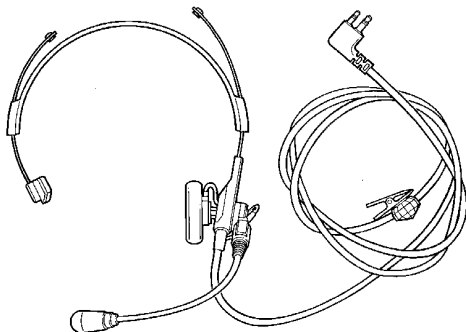

Optional Feature Enhancements

(Not Available on 2 Channel Models)

Channel Scan

This optional feature allows you to monitor a number of channels. The receiver checks each channel in a preprogrammed list for activity (up to 7 channels on the 8 channel model). Two types of channel scan are offered in the GP300; non-priority and priority scan. Both types of channel scan are available with PL/DPL operation. To initiate the scan feature, rotate the channel selector switch to the channel in which scan is programmed. If a conversation is initiated on any of the channels that the radio is scanning, the radio stops on the active channel and you can listen to the conversation.

NOTE

The GP300 scan list is not operator selectable; however, it may be reprogrammed through the Radio Service Software available at your local Motorola dealer.

- **Non Priority Channel Scan**
With this type of scan operation, no one scan channel has priority over another. The scanner stops on the first scan channel with activity, and when the activity is over and a 3-second "hang-time" has expired, proceeds to the next scan channel.
- **Priority Channel Scan**
Any one of the radio's programmed channels may be designated as the priority channel. Whenever activity occurs on the priority channel, the scanner automatically stops there and the priority alert tone is heard. Even if you are listening to another channel in the scan list, the radio automatically goes to the priority channel when there is activity.
- **PL/DPL Channel Scan**
Private-Line operation is offered with priority and non-priority channel scan. With this mode of scanning operation, the scanner stops on only the scan channels coded with the proper PL/DPL tone if PL/DPL signalling is active when you initiate scan.

NOTE

If the monitor mode is not active when the scanning feature is initiated, the radio performs a PL type of scan. If the monitor mode is active when the scanning feature is initiated, the radio performs a CSQ type of scan.

- **Talkback Scan**

This is an option, of the channel scan features listed on page 18, that is used when the PTT button is pressed when scanning has stopped on a channel. When transmit or receive activity ceases on a scan channel, a "hang time" of approximately 3 seconds occurs prior to the radio resuming scan for other channel activity. This "hang time" gives you time to receive or respond to a call before scanning resumes. The "hang-time" is programmable through the Radio Service Software available at your local Motorola Dealer.

- **Designated Channel Scan (Home Revert)**

Pressing the PTT button while the radio is scanning causes the radio to transmit on the preprogrammed designated channel location. This channel location is programmable through the Radio Service Software available at your local Motorola Dealer.

NOTE

If both Designated Channel Scan and Talkback Scan are selected, the radio transmits on the active channel. If however, there are no active channels, the radio transmits on the Designated Channel.

- **Scan Talkback Tone**

The Scan Talkback Tone feature enables you to find the last active channel received during scan mode. A beep is emitted when the channel selector knob is rotated to the last channel received during scan.

- **Scan Nuisance Delete**

When a conversation occurs and it is not your priority channel or designated scan channel, you can temporarily eliminate this channel from the scan list by pressing the side Scan Nuisance Delete button (on applicable models). To add the deleted channel back to the preprogrammed scan list, you must exit and reenter the scan function.

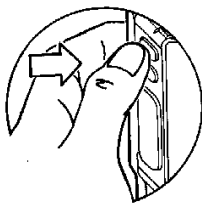

NOTE

The volume set feature is replaced whenever the side control button is programmed to operate the Scan Nuisance Delete feature.

Optional Signalling Enhancements

(Not Available on 2 Channel Models)

PTT ID

When on a channel with the PTT ID feature, the radio transmits an identification code (unit ID) to the base station, indicating which portable is in operation. This code is sent whenever the PTT button is depressed. A sidetone is heard as the ID is being transmitted; when the tone ends, start your voice message in the standard manner. The LED glows red during the time that the ID is sent out.

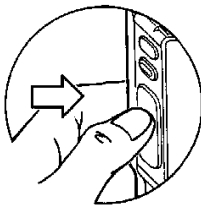

Call Alert (Decode)

Call Alert works similarly to tone-only pagers. When a Call Alert (page) is received, a series of 4 beep decode tones are heard while the LED flashes yellow. The LED continues flashing yellow and the alert tone continues until the call alert is acknowledged by the radio. If you transmit by pushing the PTT button or change the rotary channel selector while a Call Alert signal is in progress, the LED stops flashing and the Call Alert tone is disabled.

Voice Selective Call (Decode)

This feature operates like a standard pager providing a one-time voice message. When a Voice Selective Call is received by the radio, a one-time 2 beep decode tone is heard while the LED flashes yellow. The radio unmutes and the voice message is heard. The LED continues flashing yellow while the voice message is heard. The Voice Selective Call feature does not require any action to acknowledge the message and after the transmission is completed, the radio returns to normal operation.

Signalling and Channel Scan

Signalling and channel scan are compatible in the GP300 radio. However, during scan operation, a Voice Selective Call on a particular channel could be missed since the radio may not be checking that channel when the Voice Selective Call is being sent.

It is recommended that priority scan be selected and the signalling channel be designated the priority channel to improve the likelihood that the Voice Selective Call is received.

DTMF Telephone Interconnect

(Not Available on 2 Channel Models)

Dual Tone Multiple Frequency (DTMF) tones are encoded through the optional numeric keypad for access to the land-line telephone network and for remote control operation.

DTMF Telephone Interconnect

1. Press and hold the PTT button.
2. Press the desired numeric digits on the DTMF keypad. As long as the PTT button is held while the digits are pressed, the corresponding DTMF tones are transmitted.
3. Alternatively, press the **[PHN]** button on the front of the radio to activate the numeric keypad for DTMF "live-dial" transmissions. The radio automatically keys and sends digits, staying keyed for a programmable amount of time to wait for new DTMF digits.
4. Once the DTMF tones are transmitted, press the PTT button to transmit normally, without sending PTT-ID.

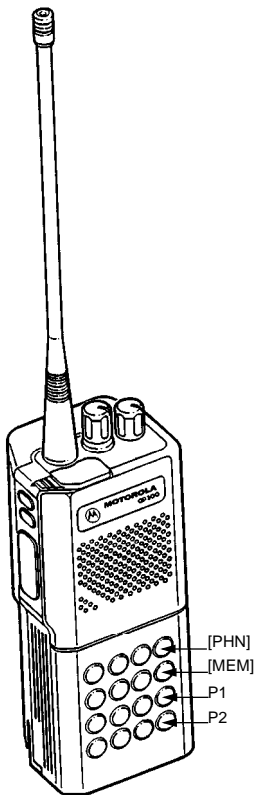

NOTE

After 7 seconds of neither transmitting nor receiving, the radio automatically resets to normal operation.

5. To return to normal operation at any time during the DTMF sequence, press the **[PHN]** button.

DTMF Preprogrammed Access/Deaccess Codes

1. Press the **[PHN]** button to activate the numeric keypad for a DTMF transmission.
2. Press the **[MEM]** button, then select the **[*]** button for the preprogrammed access code or the **[#]** button for the preprogrammed deaccess code. The radio automatically keys and sends the desired string of digits.
3. After the string is transmitted, other digits may be sent by pressing the desired DTMF numeric buttons.

DTMF Preprogrammed Repertoire List

1. Press the **[PHN]** button to activate the numeric keypad for a DTMF transmission.
2. Press the **[MEM]** button, then select a digit **[1 - 9]**. The radio automatically keys and sends the desired string of digits.
3. After the string is transmitted, other digits may be sent by pressing the desired DTMF numeric buttons.

DTMF Last Number Redial

Manually dialed DTMF numeric digits are collected while the DTMF keypad function is active. To access this stored string of digits:

1. Press the **[PHN]** button to activate the numeric keypad for a DTMF transmission.
2. Press the **[MEM]** button, then select **[0]** numeric digit. The **[0]** number location is used for storage of the last number redial function. The radio automatically keys and sends out the stored DTMF digits. This set of numbers is saved in memory until the radio is turned off or until another DTMF digit is dialed.

Dealer Programmed Control Buttons

Two dealer programmable control buttons, **[P1]** and **[P2]**, which can be programmed through the Radio Service Software available at your local Motorola dealer are also provided with the DTMF keypad model of the GP300. These additional control buttons function similarly to the buttons on the side of the radio.

Battery Information

The GP300 radio receives its power (7.5 V dc) from a rechargeable nickel-cadmium battery as listed in the accessories section. This battery, designed specifically for use in the GP300 radio, is a safe, dependable power source. Proper care of the battery will ensure its effectiveness and allow for peak performance of the radio.

Recharging Nickel-Cadmium Batteries

Recharge the battery before use to ensure optimum capacity and performance. The battery was designed to be used only with a Motorola GP300 charger. Charging in non-Motorola equipment may lead to battery damage and void the battery warranty.

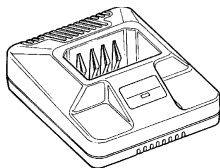

NOTE

When charging a battery that is attached to a radio, always turn the radio off to ensure a full charge.

Charging Temperature

The battery should be about 77°F (room temperature) whenever possible. Charging a cold battery (below 50°F) may result in leakage of electrolyte, and ultimately, in failure of the battery. Charging a hot battery (about 95°F) results in reduced discharge capacity, affecting the performance of the radio. GP300 rapid rate battery chargers



contain a temperature sensing circuit to ensure that the battery is charged within these temperature limits. If the charger is not performing a rapid rate charge, the charger light flashes red to indicate that the battery is being charged at a slow trickle rate. For additional information on batteries and battery charging, refer to the battery charger information in the service manual.

Short Circuit

Care should be taken to avoid external short-circuiting of the battery.

CAUTION

A sustained high rate discharge (e.g., a paper clip placed accidentally across the battery contacts) may permanently damage the battery, void the battery warranty, and create a burn or fire hazard.

Memory Effect (Reduced Charge Capacity)

The Memory Effect was a phenomenon which caused a temporary loss in battery capacity or voltage due to repetitive shallow discharging or low term overcharging. This Memory Effect has been virtually eliminated in Motorola batteries with the use of the latest in cell technology from our selected cell suppliers.

Nickel-Cadmium Battery Disposal

For disposition, Nickel-Cadmium sealed rechargeable batteries should be delivered to an authorized metals reclamation dealer (refer to the inside front cover of this manual).



WARNING

**DO NOT DISPOSE OF ANY BATTERIES
IN A FIRE AS THEY MAY EXPLODE!**

Battery Chargers Operating Instructions

NOTE

THE BATTERY IS SHIPPED FROM THE FACTORY UNCHARGED AND MUST BE CHARGED BEFORE USE.



WARNING

TO REDUCE RISK OF INJURY, CHARGE ONLY MOTOROLA NICKEL-CADMIUM TYPE RECHARGEABLE BATTERIES LISTED. OTHER TYPES OF BATTERIES MAY BURST, CAUSING PERSONAL INJURY AND DAMAGE.

- Do not expose charger to rain or snow.
- Use of an attachment not recommended or sold by Motorola may result in a risk of fire, electric shock, or injury to persons.
- To reduce risk of damage to the transformer and cord, pull by the transformer rather than the cord when unplugging the charger.
- Position cord so that it is not stepped on, tripped over, or otherwise subjected to damage or stress.
- An extension cord should not be used unless absolutely necessary. Use of an improper extension cord could result in a risk of fire and electric shock. If an extension cord must be used make sure:
 - (1) That pins on plug of extension cord are the same number, size and shape as those on plug of charger,
 - (2) That extension cord is properly wired and in good condition, and

(3) The cord size is 18AWG for lengths of up to 100 feet, and 16AWG for lengths up to 150 feet.

- Do not operate charger with damaged cord or plug – replace them immediately.
- Do not operate charger if it has received a sharp blow, been dropped, or otherwise damaged in any way; take it to your local Motorola dealer.
- Do not disassemble charger; take it to your local Motorola dealer when service or repair is required. Incorrect reassembly may result in risk of electric shock or fire.
- To reduce risk of electric shock, unplug transformer from outlet before attempting any maintenance or cleaning. Turning off controls will not reduce this risk.

To Operate Charger

1. Insert the battery, with or without the radio, into the charger pocket. (Be sure that the radio is off).
2. Put plug into the charger and plug the transformer into the appropriate AC power outlet.
3. When the battery is fully inserted, the LED glows red. The LED continues to glow red while the battery is charging.

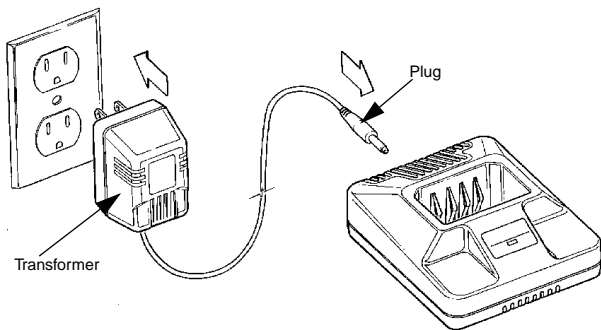

- 4a. For Single-Unit Standard Rate Battery Chargers only: When a standard-charge battery reaches full charge, no change in the LED occurs (red glow remains). The battery fully charges in 10 hours.

NOTE

You can turn the radio on while it is in the charger and have it receive normally. However, allow at least 25% more time for the battery to reach full capacity. **DO NOT TRANSMIT WHILE THE RADIO IS IN THE CHARGER.**

- 4b. For Single-Unit and Multi-Unit Rapid-Charge Battery Chargers only: When charging a rapid-charge battery, the LED glows green indicating CHARGE COMPLETE when the battery reaches full charge. This LED also indicates that the battery is now charging at a trickle rate. A LED flashes red indicating that the battery may be out of "rapid charge range". The rapid charge automatically begins when the battery is within the correct range. Typical charge times for the Rapid-Charge Battery Chargers are as follows:

1.0 Hr - 1.2 for High Capacity Battery

0.5 Hr - 0.8 Hr for Slimline Battery

NOTE

A new battery or one which has not been used for several months may cause a premature fully charged indication. These batteries should be trickle charged over night before putting them into service.

5. If the LED does not glow red when the battery is inserted into the charger, check the battery and charger contacts to be sure they are clean. There are no user serviceable parts in the charger. If the charger fails to operate, contact your local Motorola dealer.

Accessories

Motorola offers several accessories to increase communications efficiency. Many of the accessories available are listed below, but for a complete list, consult your local Motorola dealer.

Antennas:

HAD8450	— Orange	216-223 MHz VHF Antenna
HAD9338	— Yellow	136-162 MHz VHF Antenna (Standard w/Unit)
NAD6502	— Black	146-174 MHz VHF Antenna (Standard w/Unit)
HAD9742	— Black	146-162 MHz VHF Stubby Antenna
HAD9743	— Blue	162-174 MHz VHF Stubby Antenna
HAD9728	— None	Tunable Antenna Kit (136-174 MHz)
HAD9934	— Pink	174-195 MHz VHF Antenna
HAD9935	— Purple	195-208 MHz VHF Antenna
NAE6523	— Black	470-520 MHz UHF Stubby Antenna
NAE6483	— None	403-520 MHz UHF Antenna (Standard w/Unit)
NAE6521	— Red	400-440 MHz UHF Stubby Antenna
NAE6522	— Green	438-470 MHz UHF Stubby Antenna

NOTE

Each of the color coded antennas listed is designed to cover only the frequency split indicated. Therefore, it is important to order the correct antenna (frequency split) to match a specific customer frequency.

Carrying Accessories:

HLN9149	Swivel Belt Loop Adapter (for use with HLN9720, HLN9721, HLN9750, HLN9970, and HLN9008)
HLN9720	Standard Leather Carry Case w/Belt Loop
HLN9873	Standard Leather Carry Case w/Swivel
HLN9721	Slim Leather Carry Case w/Belt Loop
HLN9076	Standard Molded Carry Holster w/Belt Clip
HLN9750	Standard Nylon Carry Case
HLN9970	DTMF Standard Leather Carry Case w/Belt Loop
HLN8411	DTMF Standard Leather Carry Case w/Swivel
HLN8412	DTMF LCD Standard Leather Carry Case w/Swivel (Avail APD Only)
HLN9008	Leather Carry Case w/Belt Loop for fully approved FM 1200 mAH Battery
HLN9009	Leather Carry Case w/Swivel for fully approved FM 1200 mAH Battery
HLN9011	DTMF Carry Case w/Swivel for fully approved FM 1200 mAH Battery
HLN9017	Nylon Carry Case for fully approved FM1200 mAH Battery
HLN8414	Chest Pack Carry Holder
HLN9985	Waterproof Bag
HLN9724	Replacement 2 ¹ / ₂ " Belt Clip
HLN8255	Spring Action 3" Belt Clip
HLN8052	Wrist Strap
NTN5243	Shoulder Strap (for use with all carry cases)

Carrying Accessories Available Through APD Only:

HLN9035	Replacement 2 ¹ / ₂ " Swivel Belt Loop (for use with HLN9873, HLN8411, HLN8412, HLN9009, and HLN9011)
---------	---

NTN5629	Replacement 3" Swivel Belt Loop (for use with same carry accessories as 2 ¹ / ₂ " Belt Loop but with wider belts)
HLN9084	Replacement Strap for Molded Carry Holder
HLN9973	Replacement Strap for Leather Carry Case
HLN9974	Replacement Strap for Nylon Carry Case
HLN9975	Replacement Strap for DTMF Carry Case
HLN9018	Replacement Strap for fully approved FM 1200 mAH Battery Leather Carry Case
HLN9019	Replacement Strap for fully approved FM 1200 mAH Battery Nylon Carry Case

Nickel-Cadmium Battery Chargers:

HTN9630	110 Volt – 1 Hour Rapid Rate Charger
HTN9702	110 Volt – 10 Hour Standard Rate Charger
HTN9748	110 Volt – 6 Unit – 1 Hour Rapid Rate Charger
HTN9886	100 Volt – 1 Hour Rapid Rate Charger
HTN9938	100 Volt – 6 Unit – 1 Hour Rapid Rate Charger
HTN9802	220 Volt – 1 Hour Rapid Rate Charger (European Plug)
HTN9804	220 Volt – 10 Hour Standard Rate Charger (European Plug)
HTN9803	240 Volt – 1 Hour Rapid Rate Charger (U.K. Plug)
HTN9805	240 Volt – 10 Hour Standard Rate Charger (U.K. Plug)
HTN9812	240 Volt – 6 Unit – 1 Hour Rapid Rate Charger (U.K. Plug)
HLN9719	1 Hour Vehicular Charger Adapter/Bracket (12 volt for use with HTN9630, HTN9802 or HTN9803 Rapid Rate Chargers)
HLN9944	Wall Mounting Bracket for Multi Unit Charger (Avail. APD Only)
HKN8036	Battery Eliminator

Batteries:

HNN9628	1200 mAH Standard Battery
HNN8133	1200 mAH Limited FM Battery
HNN8308	600 mAH Slimline Battery
HNN9808	600 mAH (Fully Approved FM Slim Battery)
HNN9701	1200 mAH (Fully Approved FM Battery)

Audio/RF Accessories:

HMN9725	Remote Speaker Microphone
HMN9727	Earpiece Without Volume Control (plastic earloop)
HMN9752	Earpiece With Volume Control (plastic earloop)
HMN9754	2 Piece Surveillance Microphone (plastic earloop)
HMN9787	Headset w/Swivel Boom Microphone
BDN6647	Medium Weight Headset w/ Boom Microphone
BDN6648	Heavy Weight Headset w/Noise Cancelling Boom Mic.
BDN6646	Ear Microphone
BDN6706	Ear Microphone with VOX Interface (external VOX included)
BDN6720	Flexiable Ear Receiver
HLN8096	Audio Accessory Clamp
HLN9756	BNC – RF Adapter (for use with GP300 models only)
50-80386B90	Rubber Ear Inserts (for earpieces with older metal earloop - 25 per package)
50-80371E73	Rubber Ear Inserts (for earpieces with plastic earloops 25 per package)

Belt Clip Installation Instructions

To facilitate installation, refer to the following diagram while performing the following steps:

To Attach The Belt Clip To The Radio:

1. Locate the mounting rails on the back side of the radio.
2. Position the belt clip, Motorola logo facing up, so the logo end of the clip is nearest the mounting rails, and the other end of the clip is toward the bottom of the radio.
3. Align the mounting rails with the grooves in the belt clip. Slide the belt clip onto the mounting rails until it latches into place (indicated by a click)

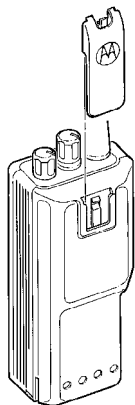

To Remove The Belt Clip:

1. Locate the belt clip release tab on the underside of the belt clip (Motorola logo end).
2. Lift the release tab by inserting a key or coin between the release tab and the back surface of the radio.
3. While holding the key or coin firmly under the release tab, pry up until the belt clip slides slightly toward the bottom of the radio.
4. With the belt clip fully released (when the release tab is pressed against the inside surface of the belt clip), slide the belt clip off the mounting rails.

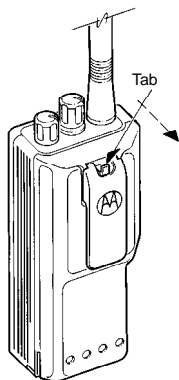

For Use in Hazardous Atmospheres

For information referencing the Factory Mutual approved GP300 Models, Options and Accessories, refer to the ***Factory Mutual Approval Manual Supplement (6880902Z27)***.

Troubleshooting

If you experience difficulty, check the following items before requesting service.

1. Review steps under OPERATION.
2. Be sure the rotary channel selector switch is set to the correct channel.
3. Replace or recharge the battery.
4. If reception is poor, check the antenna. It must be undamaged and operated in the vertical position for best reception.
5. Try several different operating locations, especially when operating the radio inside buildings.
6. Check transmitter by transmitting to another portable radio or communications receiver. If the receiver has a signal strength ('S') meter, make comparison readings against another portable radio.

Service

Because this unit contains a radio transmitter, federal law prohibits anyone from making any internal adjustments to the transmitter unless specifically licensed to do so by government regulations. If your radio fails to operate, contact your local Motorola dealer.

Proper repair and maintenance procedures assure efficient operation and long life for this radio.

General Radio Care

1. Avoid physical abuse of your radio such as carrying it by the antenna or remote microphone.
2. Wipe the battery contacts with a lint-free cloth to remove dirt, grease, or other material which may prevent good electrical connections.
3. When not in use, keep the accessory connector covered with the protective cap.
4. Clean the radio exterior using a cloth moistened with water. See Caution.

CAUTION

Use of chemicals such as detergents, alcohol, aerosol spray, and/or petroleum products may be harmful and damage the radio housing and cover. Refer to the inside front cover of this manual.

Safety Information

The Federal Communications Commission (FCC) with its action in General Docket 79-144, March 13, 1985 has adopted a safety standard for the human exposure to radio frequency (RF) electromagnetic energy emitted by FCC-regulated equipment. Proper operation of this radio will result in user exposure substantially below the FCC recommended limits.

Your hand-held portable radio should be held in a vertical position with the microphone 2.5 to 5 cm (1 to 2 inches) from the mouth and the antenna should be kept 2.5 to 5 cm (1 to 2 inches) away from the head or body when transmitting. For body worn operation, the antenna should be kept at least 2.5 cm (one inch) away from the body when transmitting.



DO NOT hold the transmit PTT button on when not actually desiring to transmit.

DO NOT allow children to play with any radio equipment containing a transmitter.

DO NOT operate a portable transmitter near unshielded electrical blasting caps or in an explosive atmosphere unless it is a type especially qualified for such use.

DO NOT operate the radio with a headset or other audio accessories at high volume levels. Hearing experts advise against continuous high volume operation. If you experience a ringing in your ears, reduce the volume level or discontinue use.

Computer Software Copyrights

The Motorola products described in this manual may include copyrighted Motorola computer programs stored in semiconductor memories or other media. Laws in the United States and other countries preserve for Motorola certain exclusive rights for copyrighted computer programs, including the exclusive right to copy or reproduce in any form, the copyrighted computer program. Accordingly, any copyrighted Motorola computer programs contained in the Motorola products described in this manual may not be copied or reproduced in any manner without the express written permission of Motorola. Furthermore, the purchase of Motorola products shall not be deemed to grant, either directly or by implication, estoppel or otherwise, any license under the copyrights, patents or patent applications of Motorola, except for the normal non-exclusive royalty-free license to use that arises by operation of law in the sale of a product.

Licensing Information

Your Motorola radio operates on FM radio communication frequencies and is subject to the Rules and Regulations of the Local Communications Governing Agencies. These agencies may require that all operators using Private Land Mobile or General Mobile Radio frequencies obtain a radio license before operating their equipment. The operator receives a license for use of the radio equipment under a specific eligibility and on a particular frequency or set of frequencies. To determine eligibility for use of Private Land Mobile Service frequencies, contact your local communications governing agency. They are able to supply information required to properly obtain and complete the license application form:

Agency addresses for several countries are listed below:

In the United States contact:

Federal Communications Commission
Consumer Assistance
Branch License Division
Gettysburg, PA 17326
Tel. (717) 337-1212

In Canada contact:

Head Equipment Approval Unit
Department of Communications
1241 Clyde Avenue
Ottawa, Ontario K2C-1Y3
Canada
Tel. (613) 998-5968

In the United Kingdom contact:

Radio Communications Agency
P.O. Box 20
London
SE1 8TZ
Tel. 71 215 2152

In Mexico contact:

Secretaria De Comunicaciones Y Transportes
Direccion General De Politicas
Y Normas De Comunicaciones
Av. Eugenia No. 197-5o. Piso
Mexico, D.F. 06700

In Singapore contact:

Telecommunications Authority of Singapore
3rd Storey Comcenter
31 Exeter Road
Singapore, 0923
Singapore

In Japan contact:

Communications Research Laboratory
Ministry of Posts & Telecommunications
MKK Building
7-2, 5-chrome
Yashio, Shinagawaku
Tokyo, 140 Japan

In Hong Kong contact:

Hong Kong Telecommunications Authority
Telecommunications Branch
Post Office, Hong Kong
6/F Sincere Building
173 Des Voeux Road Central
Hong Kong